

**AGENDA
ITEM**

12

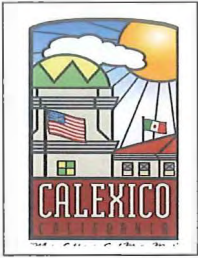

AGENDA STAFF REPORT

DATE: November 3, 2021

TO: Mayor and City Council

APPROVED BY: Miguel Figueroa, City Manager *MK*

PREPARED BY: Lilliana Falomir, Public Works Manager – Administrative *L. Falomir*

SUBJECT: Authorize City Manager to Purchase Grass Seed, Fertilizer and Sport Soil in the Amount of \$31,924.68 from SiteOne Landscape Supply for Adrian C. Cordova Memorial Baseball Fields.

=====

Recommendation:

Authorize City Manager to purchase grass seed, fertilizer and sport soil in the amount of \$31,324.68 from SiteOne Landscape Supply for Adrian C. Cordova Memorial Baseball Fields.

Background:

On February 11, 2020, the City of Calexico Public Works Department requested bids for Adrian C. Cordova Baseball Fields Fencing Project No. 2020-200. The project consists of the installation of three (3) baseball field fences at Adrian C. Cordova Memorial Park located on Clinton Avenue between Zapata Drive and Meadows Drive. On March 18, 2020, the City Council of the City of Calexico awarded a construction contract to Crafters Fence, Inc. in the amount of \$167,750.00 for the above-mentioned project. Due to additional work that was not anticipated during the design phase of said project, the City Council of the City of Calexico authorized the City Manager to sign one (1) change order. The total project cost is \$207,650.00. On September 24, 2020, Crafters Fence, Inc. completed Adrian C. Cordova Baseball Fields Fencing Project No. 2020-200.

Discussion & Analysis:

For several months, Public Works staff had been reaching out to several landscaping companies requesting proposals for the purchase of grass seed, fertilizer and sport soil for the three (3) baseball fields at Adrian C. Cordova Memorial Park. Due to the shortage of staff and product availability, Public Works staff was finally able to get a representative from a landscaping company in San Diego, California to come down and visit

AGENDA
ITEM
12

the site. On October 18, 2021, a representative from SiteOne Landscape Supply's visited and measured the three (3) baseball fields at Adrian C. Cordova Memorial Park and provided Public Works staff a proposal for the purchase of grass seed, fertilizer, and sport soil. Please note that the hydr mulching includes both Bermuda, which will grow in the spring and a winter. In addition, the sport soil (turf product) is for the infield and warning tracks for safer play and water management and is used by most little, high school, college and pro teams. Public Works staff is requesting that the City Council of the City of Calexico authorize the City Manager to purchase grass seed and sport soil for three (3) baseball fields from SiteOne Landscape Supply in the amount of \$31,924.68.

Fiscal Impact:

Capital Improvement Program Budgeted Item for FY 2021-2022	
Bravo – Victoria/Eastside Village (261-90-978-56003-000)	\$31,924.68
Total	\$31,924.68

Coordinated With:

Public Works Department.

Attachment(s):

1. SiteOne Landscape Quote No. M114148538.

Working Order



San Diego CA #102
5805 Kearny Villa Rd
San Diego, CA 92123-1113
W: (858)560-6611

Sold To:

City of Calexico - Public works (#1806871)
608 Heber Ave
Calexico, CA 92231-2840
W: (760)768-2160

Ship To:

City of Calexico - Public works (#1806871)
City of Calexico
608 Heber Ave
Calexico, CA 92231-2840
W: (760)768-2160

**For Chemical Emergency Spill, Leak, Fire,
Exposure, or Accident Emergency Response
Assistance, call: CHEMTREC
Day or Night- 1 (800) 424-9300**

Ordered	Master Order#	PO#
10/26/2021	M114148538	
Printed	Customer Contact	Sales Associate
10/26/2021		Eric McGinnis

Order#: 114148538-001 Ship Via: Customer Pick up

LN	Item #	Description	Qty Ordered	Qty Cancelled	Qty Shipped	Qty Open	Net Price	Ext. Price
1	SFEFW	Ecofibre Wood Hydromulch (50#) <i>Item Note:</i> 2,000 lbs per acre	160	0	0	160	20.213 / EA	3234.08
2	PLANTAGOTAC	Plantago Tackifer 50 lb. <i>Item Note:</i> 50# per acre	4	0	0	4	34.990 / EA	139.96
3	23-35-835	LESCO Dune Bermudagrass Seed (Coated/Treated) 25 lb. <i>Item Note:</i> 3lbs. per 1,000 sf	20	0	0	20	116.291 / EA	2325.82
4	098511	LESCO Organic/Organic-Base Fertilizer 15-15-15 33% PolyPlus OPTI45 25% Bio 50 lb. <i>Item Note:</i> 7,500 sf per bag	22	0	0	22	29.586 / EA	650.89
5	28-837-82	LESCO SW College Ryegrass Seed Blend 50 lb. <i>Item Note:</i> 10lbs per 1,000sf	33	0	0	33	121.218 / EA	4000.19
6	088782	LESCO Turface All Sport Soil Conditioner Infields 50 lb. <i>Item Note:</i> 8 tons per field - Infield, behind home plate and warning tracks.	960	0	0	960	13.180 / EA	12652.80
7	088972	Turface Professional Mound Clay Red 50 lb. <i>Item Note:</i> 82 each field - baseball 41 softball field	205	0	0	205	19.082 / EA	3911.81
8	SF5STAR1000	Turface 5 Star Mound Packing Clay (50 lb.) bag	40	0	0	40	14.500 / EA	580.00
9	12901010	jack corbett hollyhood baseset of 3	3	0	0	3	195.000 / EA	585.00
10	12908170	Hollywood Bury All Home Plate	3	0	0	3	165.570 / EA	496.71
11	PR-1000	Hollywood 4-sided pitching rubber	3	0	0	3	173.477 / EA	520.43
12	205-435-010	Beacon Rigid Steel Mat Drag 4 ft. x 18 in.	1	0	0	1	187.646 / EA	187.65
13	12536	36 in. Dual Purpose Double Play Rake 66 in. Blue Alum Hand	1	0	0	1	64.705 / EA	64.71
14	SPYDER	Forklift Delivery On Truck	1	0	0	1	300.000 / EA	300.00

Subtotal:	\$29650.05
Sales Tax:	\$2274.63
Freight:	\$0.00
Estimated Total:	\$31924.68

This working order is for reviewing purposes only. This is not a receipt.

CUSTOMER SIGNATURE: _____

SiteOne Landscape Supply warrants that all products conform to the description on the label. Because conditions of use, which are of critical importance are beyond our control, seller makes no warranty, expressed or implied, concerning the use of these products. No employee of the company is authorized to make any warranty or representation, expressed or implied, concerning our products. Always follow directions and carefully observe all precautions on the label or manufacturer's instructions. Products used contrary to directions may cause serious plant or personal injury. Buyer assumes all risk of use of handling whether in accordance with direction or not and accepts the products sold to them by this company on these conditions.

Note: Returns subject to 25% restock charge.

**TURFACE
ATHLETICS**

Your Home Field Advantage™

FIELD MAINTENANCE

**TOP 10
TIPS**

INSIGHTS AND ADVICE

from Professional Groundskeepers

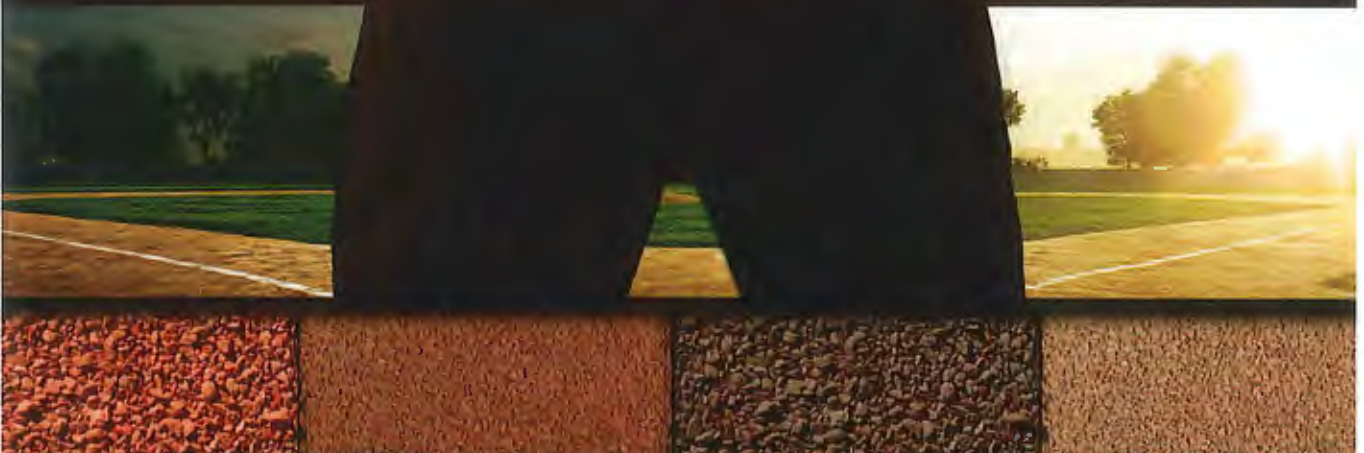

The #1 Conditioner for Safe & Playable Fields

TOP 10 FIELD MAINTENANCE TIPS

	PAGES
1. Know Your Field	3
2. New Construction: Do It Right The First Time	3
3. Create Safe High-Performance Infields	4-6
4. Maintain The Perfect Base Path	7
5. Use Proper Dragging Techniques	8
6. Water Is Your Most Important Maintenance Tool	9
7. Make Puddles A Thing Of The Past	10
8. Turface Mound Clay	11-12
9. Turface® MoundMaster® Blocks	13-14
10. Turface Athletics™ For Outstanding Turf	15-16
Bonus: Field Dimensions	17-22

SELECTING INFIELD CONDITIONERS

CALCINED CLAY—THE #1 CHOICE

Turface MVP®, Pro League®, Quick Dry® and Field & Fairway™ are calcined clay products manufactured specifically to condition sports fields to improve drainage, reduce compaction and absorb excess water. Tremendous variation exists between Turface® calcined clays and other products. Many materials are considered field conditioners, and many claim to be “just like” Turface. However, the degradation of Turface calcined clay is just 3% over 20 years – far superior to other “field conditioners” that degrade or melt back down to clay in a few days. Turface is the #1 Choice of Groundskeepers because of its unique mineral properties and the manufacturing process, which produces a very stable, uniform particle with consistent color and little dust.

LESSON TO BE LEARNED | The value of a product is measured by what’s in the bag, not the price tag on the bag.



TURFACE SLIDE MASTER THE ULTIMATE SLIDING SURFACE

A new premier topdressing solution from Turface Athletics! Turface SlideMaster™ is specially formulated with consistent sub-angular particles that provide the ultimate sliding surface for skinned infields! The particles let water pass through to the infield skin, helping improve water management especially in hot or dry weather. Turface SlideMaster™ is an expanded shale that can be used as a stand-alone topdressing or can be combined with industry-leading Turface calcined clays to allow you to better manage playing conditions and surface moisture.

LESSON LEARNED | Turface SlideMaster™ works in concert with Turface calcined infield conditioners to allow water to move through the topdressing layer more quickly, saturating the infield mix when conditions are hot and dry



TIP #1 KNOW YOUR FIELD

The #1 concern for a coach and a groundskeeper is the safety of the athletes that play on their fields. The only way to accomplish this is to walk your field every day and look for hazards.

JOSH MARDEN
Turface Athletics
Former Groundskeeper,
Durham Athletic Park



TIPS FROM THE PROS

RECORD KEEPING

- Good timing results in maximum performance of staff, equipment and the field.
- A calendar should track daily jobs, attendance, injuries, performance and field usage.
- Good staff records are never disputable.
- Record weather conditions.
- Keep equipment logs for each piece of equipment.
- Replace defective equipment immediately and log this work.
- A soil analysis provides a baseline and ongoing guide to monitor your inputs.
- Keep a log of all maintenance practices and products (with detailed rates) applied to field.

TIP #2 NEW CONSTRUCTION: DO IT RIGHT THE FIRST TIME

Being able to build a field from scratch is a groundskeeper's dream. It is a chance to eliminate any problems from the start. You only get one chance at building a field, so you have to make the most of the opportunity. Money spent wisely in construction will save money in years to come.

GRANT TRENBEATH
Head Groundskeeper
Arizona Diamondbacks



TIPS FROM THE PROS

- Sub-grade should direct water away from the infield and toward drainage lines.
- Trenches need to be graded so that drain lines use gravity to help get water off the field.
- Install vertical blow out access to drain lines for easy cleaning in case they clog.
- Place quick coupler valves during irrigation layout for easy hand watering later. Place in middle of the infield and around the perimeter of the outfield.
- When preparing a final grade, use laser equipment for a precise slope. Consider the thickness of the sod if you do not seed or sprig before finalizing the grade.
- Infield mix should be a good clay/sand blend based on your region.
- Incorporate Turface MVP® or Pro League® into infield mix to help with drainage and provide a safe, consistent surface.
- Turface Pro League dragged into the top 1" protects my clay base by retaining moisture and providing a very smooth surface.
- Use pure clay (Turface® MoundMaster® Blocks or Professional Mound Clay®) on the mound and batter's boxes. Topdress with a light coating of Turface MVP or Pro League.

TIP #3

CREATE SAFE HIGH-PERFORMANCE INFIELDS

For over 50 years, Turface® has set the standard for sports field maintenance, providing affordable solutions to field maintenance problems. With Turface incorporated into your sports fields, athletes will have the opportunity to perform at their highest levels. Compaction, bad ball hops and rainouts are significantly reduced.

BOB CHRISTOFFERSON
Head Groundskeeper
Seattle Mariners



Soil Selection for my Major League Diamond

My mix contains significantly more clay than is typically used at the park and rec level. It's important to condition your soil by incorporating Turface at about a 20% rate, 4" deep to allow excess water to drain and to keep the clay from becoming too hard. The infield needs to be consistent throughout nine innings. Rainouts aren't a factor at Safeco because I have a retractable roof, but I still rely on Turface as an excellent water management tool. It helps me maintain a proper moisture level in my field and will help you to prevent rainouts.

TIPS FROM THE PROS

JAR TEST

Determine the sand, silt and clay composition of infield soils.

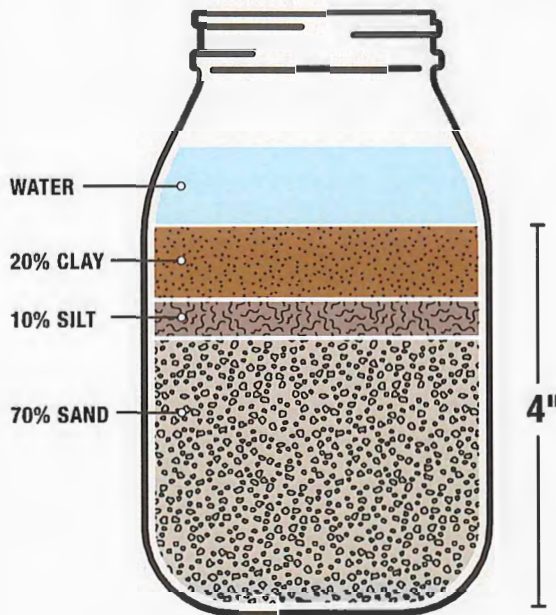

STEP 1

- Take approximately 4-5 plugs of soil samples (from the surface to the bottom of your infield mix) and blend them all together.

STEP 2

- Fill a straight-sided jar with 4" of the infield mix.

STEP 3

- Fill the jar with water to within a couple inches of the top. Shake until the soil is thoroughly mixed with the water and starts to disperse (about 10 minutes).

STEP 4

- Let stand until settled (this could take overnight). Every inch = 25%.

Note: adding a tablespoon of salt to the mixture will improve the speed of settling!

Percentages represent a balanced infield mix, optimum for a recreational facility with fewer maintenance resources.

For facilities that have greater access to water, staff and maintenance equipment, a higher clay content can be effectively managed.

TURFACE® BASEBALL AND SOFTBALL RENOVATION

Turface is used by more groundskeepers than any other sports field conditioner because of the quality and conditioning Turface provides to the infield soil. Turface ensures a safe field that holds up to rain and gives athletes a chance to perform at their best. Expect major league results when you incorporate Turface MVP into your diamonds.

TURFACE MVP: Complete Infield Renovation



STEP 1: Moisten the skinned area. Spread Turface MVP bags evenly throughout the skinned areas to be renovated. Depending on the amount of Turface required, align the bags 42" to 60" apart in both directions.



STEP 2: Once Turface MVP bags are properly positioned, open bags and dump material. Remove all Turface bags from the field.



STEP 3: With a blade, mat drag, or landscape rakes, level all of the Turface piles and spread evenly across the surface.



STEP 4: Rototill the Turface MVP into the existing infield mix to a depth of 3" to 4". Drag the infield with a mat drag to break up clumping. Level the field.



STEP 5: Roll the infield with a one-ton roller or a hand roller. This helps speed up the settling process, allowing the field to firm up more quickly.



STEP 6: Slowly drag the infield twice with a mat drag. This will loosen the surface to a desired consistency and level any visible low spots. After, rake or sweep all edges to remove any loose material from the turf. This will prevent any lips from forming.

TURFACE® MVP®: Application Rates Tilled 4" Deep

RENOVATION CHART: Entire Skinned Area

BASEBALL*	SOFTBALL*	LITTLE LEAGUE*
10 tons	9 tons	3 tons
Approx. Rate: 1.5 tons (1,500 kg) of Turface MVP per 1,000 sq ft (92.9 m ²)		

PROGRESSIVE INFIELD RENOVATION**

BASEBALL	SOFTBALL	LITTLE LEAGUE
3 tons	2 tons	1 ton

*Assumes grass infield; use double the amount of Turface if completely skinned.**Annually over 3-4 years.

OTHER APPLICATIONS

	BASEBALL	LITTLE LEAGUE
Pitcher's Mound	1-2 bags	1 bag
Home Plate	1-2 bags	1 bag
Base Paths	2-3 bags	1-2 bags

Use 50-lb bags, rake into the surface. To topdress with 1/8" of Turface, apply at a rate of 375 lbs per 1,000 sq ft.



Turface® MVP®

TURFACE® PRO LEAGUE®: Application Rates

TOPDRESSING OR COLOR

BASEBALL	SOFTBALL	LITTLE LEAGUE
1 ton	3/4 ton	1/2 ton



Pro League®
Champion Brown™



Pro League
Heritage Red™



Pro League®
Red

Winning on a Small Budget with Turface

Lack of funds are all too common for coaches and groundskeepers and result in decisions to purchase brick dust/vitrified clay, limestone screenings, shale, sand or other by-products to try and keep a field playable during rain. These products do not condition a field like Turface and may lead to larger problems down the road. Turface has a degradation factor of just 3% over 20 years, lasting season after season to condition fields. If your budget prevents you from doing a complete renovation, apply 2 to 3 tons of Turface into the top 1 to 1.5 inches with a nail drag. You will see immediate improvement while working your way to a completely renovated field in 4 to 5 years.

TURFACE MVP or PRO LEAGUE: Progressive Infield Renovation (4-5 years)



STEP 1: Lightly moisten the skinned area to loosen the surface in preparation for mixing the Turface MVP into the soil. Do not soak.



STEP 2: Spread 2-3 tons of Turface MVP evenly over the infield.



STEP 3: Nail drag the infield twice, working the Turface MVP into the top 1-1.5" of the playing surface. This will ensure that the Turface is incorporated evenly.

TIP #4

MAINTAIN THE PERFECT BASE PATH

Keep Base Paths Firm

A firm base path means a fast base path. With this in mind, it is important to keep your base paths firm and level. We use 100% clay on the first and third base paths topped with Turface. After every event you should sweep the soil out of the grass. Use a hose to wash the soil out of the grass if the lips become bigger.

ROGER BAIRD
Assistant Director,
Grounds
Chicago Cubs



TIPS FROM THE PROS

OUTSTANDING BASE PATHS

- Till 2 bags of Turface® MVP® or Pro League® into the top 2" of the dirt along your first and third base paths. Moisten base paths without saturating. Roll your base paths until firm.
- Frequently level, water and roll the first base area to keep firm and prevent bad hops. There's less clay here, and rolling is a must.
- Spread 2 or 3 bags of Turface MVP or Pro League over the surface of the base paths for maximum moisture control and surface consistency.
- If rain is expected, add another bag of Turface MVP or Pro League so you do not have to come out to add Turface during a light rain.
- Hand rake base paths lengthwise to prevent lips.

Ivy on the Outfield Wall

The grounds crew is in charge of the ivy. The ivy was planted in 1937 and consists mostly of Boston Ivy. Every week it takes 16 hours to trim the ivy at the top of the wall and around the doors and numbers. We use a handheld trimmer to cut each strand pulled from the wall. We collect clippings in the fall and cultivate them at home over the winter. These new plants are used to fill areas that need repair. Strong vines are redirected to grow into weak areas during the season. We fertilize with triple 19 twice per year with a shot of iron in the spring. In the fall the vines begin to lose their leaves and we are the only park in the major league that has to rake leaves before games.



TIP #5

USE PROPER DRAGGING TECHNIQUES

Dragging an infield has turned into an art form. When performed properly it keeps your surface in top shape. When done incorrectly, maintenance issues can arise. A nail drag and a mat drag are necessities. Nail drags smooth out cleatmarks and small imperfections after a game. It also helps break up the surface to allow water to penetrate, while incorporating Turface® into the top portion of infield material.

MICHAEL BOETTCHER
Head Groundskeeper
Milwaukee Brewers



Dragging Patterns

Dragging your infield daily is a great practice. However, if you continuously use the same dragging patterns, high and low spots can develop, creating inconsistencies on your infield surface and baselines. By changing up your patterns, you can keep a level, consistent surface throughout the season, allowing your infield to surface drain and play properly.

TIPS FROM THE PROS

INFIELD DRAGGING

- Remove bases and place plugs into the sleeves
- Cut down high areas around bases with hand nailing and the teeth on infield scrapers
- With some moisture in your infield mix, nail drag your skin to help loosen the top 1/2" and smooth any minor imperfections
- Water your infield and let it infiltrate the soil. Angle the stream of water to simulate rain and have someone hold the hose to keep from pulling Turface into piles and into the grass
- To achieve a nice smooth, finished surface, begin mat dragging after the infield surface has dried. Alternate your dragging patterns and starts/stops
- When using an infield groomer, drag slowly and stay 12" from the turf edge to avoid pushing conditioner into your turf
- Edges, home plate and baselines should be worked by hand with rakes, nail drags, and finally a hand mat
- Match drag widths to base path dimensions so one or two full passes completes the task
- Monitor your nail drag throughout the season and sharpen/replace your nails as needed.

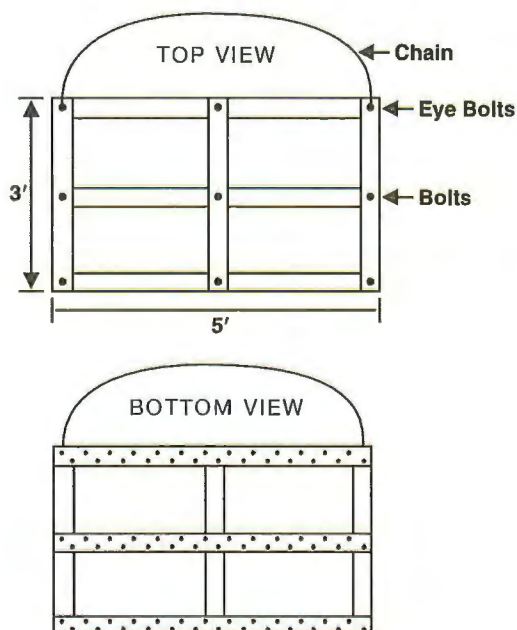

How to Build a Nail Drag

A nail drag is the ideal tool for maintaining a smooth and consistent infield surface. By using a nail drag on a Turface infield, your field will have the look and feel of a professional ball park. Use the following components to build your nail drag:

- Build with 2" x 4" wood
- Pre-drill straight holes for nails
- Use 40 penny nails
- Stagger nails 1 3/4" apart—2 rows in each board
- Use a 1" x 4" piece of wood to cover 2" x 4" on top to hold in nails
- Screw eye bolts into the corners of the drag so that a chain can be attached to pull the drag.
- Different sizes can be built to accommodate your infield, baselines and home plate.

TIP #6

WATER IS YOUR MOST IMPORTANT MAINTENANCE TOOL

Proper infield maintenance is virtually impossible without water. Proper infield moisture is the key ingredient for a professional quality infield.

BRANDON KOEHNKE
Head Groundskeeper
Cleveland Indians



Water Infield Daily or as Often as Possible

If the infield is not watered properly, it will become either rock hard or powdery. Neither is good for the athletes. To maintain good moisture levels, start early in the day. I start watering 8 to 10 hours before a game and water heavily. Water must migrate deeply into the infield soil. Moisture provides your infield with body and holds the soil together resulting in firm footing for the athlete. Weather will dictate how much water is needed to be applied right at game time, and I hand water with a hose before the game. Incorporating Turface® MVP® or Pro League® is essential for a conditioned infield because Turface® absorbs moisture and slowly releases it back into the soil, creating a balanced moisture reservoir in the infield mix. Turface helps regulate the need for watering.

Water Turf Deeply

Once you have established turf on your field, it is best to irrigate deeply once or twice a week (avoid frequent, light watering). This forces roots to seek water down in the soil, resulting in a stronger, deeper root system. REMEMBER: Water your turf immediately after an event for improved recuperation.

Water Pitcher's Mound and Batter's Boxes Often to Keep Clay Moist

Because your pitcher's mound and batter's boxes are constructed with heavy packing clay, it is necessary to keep them moist to prevent them from cracking. Covering your pitcher's mound and home plate areas after a light watering is the ideal maintenance practice. If you do not cover these areas, coating them with a light covering of Turface MVP or Pro League can assist in maintaining moisture levels in these areas.

TIPS FROM THE PROS

MANAGING INFIELD MOISTURE

- Water early in the day (8 to 10 hours before game time), slowly and heavily to let water migrate deeply into the soil profile.
- Condition your soil with Turface MVP or Pro League to absorb moisture and slowly release it back into the soil. This maintains a uniform release of moisture for optimum firmness.
- Nail drag in a couple of tons of Turface each year to help regulate surface moisture.
- Have someone hold your hose to avoid dragging across the infield.



TIP #7

MAKE PUDDLES A THING OF THE PAST

Surface® Quick Dry® is specially designed to absorb infield puddles. Quick Dry is sized for greater surface area to eliminate puddles instantly. Unlike corn cob absorbents, Quick Dry will not harden when dry and becomes a part of your infield, working over and over.

LARRY DIVITO
Head Groundskeeper
Minnesota Twins



Puddle Prevention

Proper grading and daily maintenance will help eliminate low spots. Bring in more infield mix to level the area. Tamp or roll these areas to match the firmness of the surrounding soil. Top with Surface® MVP® or Pro League.



Large Puddles

Fill a 1" hose with water, surround the puddle, and pull the water off the back edge of the skinned infield. Sponge rollers also work well. Then, apply Surface Quick Dry to soak up any remaining water. Rake into the infield mix.

This process will keep your field level and will minimize the amount of infield material pulled into your turf.

FIELD & FAIRWAY



Natural

Emerald

Puddles and Mud in Grass

To remove water from turf areas, Field & Fairway™ should be topdressed and raked over the puddles to absorb water.

To prevent puddles, core aerify and topdress with Field & Fairway dragging it into the holes. Frequent topdressing with sand and Field & Fairway will raise the low areas and help stop puddle formation.



TIPS FROM THE PROS

PUDDLE PREVENTION

- Maintain grade around bases and in player positions. Fill low spots with infield mix and topdress with Surface MVP or Pro League.
- Remove puddles as soon as possible to prevent surrounding areas from getting saturated.
- Minimize or remove lips so water can drain away from skinned areas.
- Keep the infield moisture level lower when rain is expected.
- Keep mounds and home plate areas covered since these high clay areas are the hardest to dry out.

TIP #8 SURFACE MOUND CLAY

Surface Mound Clay should be used in the table and landing areas of the mound. The objective is to use this specialty clay to create solid footing right at the surface of the mound.

The depth of your mound clay depends on the level of play.

Fourteen years old or younger require a 4" depth and 6" are required for older players. 3" to 4" should be used on the flat table around the rubber. I like to fan out the clay into the landing areas from 45 to 50 degrees off of each front corner of the rubber. This width will ensure pitchers with odd follow throughs will not be injured by landing on soft spots on the mound.

DAVID MELLOR
Director of Grounds
Boston Red Sox



The Foundation for Safe and Durable Mounds and Boxes

No areas around the diamond or in the bullpen receive more wear and tear than pitcher's mounds, batter's boxes and catcher's boxes. It is crucial these areas be properly maintained to assure on-the-field safety and playability, pitch after pitch. The performance and durability of Turface Mound Clays and MoundMaster Blocks provide the right foundation allowing athletes at every level to compete to the best of their abilities.



NEW! 5-STAR™ PACKING CLAY

A reliable, high-density mound and plate clay that's easy to install and maintain – at a competitive price.

- High density – red clay material with a high silt and clay content for strong bonding during installation
- Ready to use – just open the bag, pour, and pack
- Durable – stands up to high levels of on going wear, even with larger athletes



5-STAR™ PACKING CLAY
Available in truckloads (bulk), 50-lb. bags or 2,000-lb. Super Sacks

TURFACE MARMOUND ALL-PURPOSE PACKING CLAY®

Turface MarMound All-Purpose Packing Clay is an affordable and easy to use packing clay for mound and plate management.



TURFACE® MOUNDMASTER® BLOCKS

These pre-compressed blocks have a high density for increased durability, yet are pliable, and are ready for use right out of the bag.

- 100% pure virgin clay delivers long-lasting performance
- Sized right for building batter's and catcher's boxes and pitching mounds
- 8-block sets are packaged in water tight bags to retain proper moisture, and are available in red or gray



8-BLOCK BAGGIES:

304 blocks per pallet; 8 blocks per bag – easily repairs holes in front of pitchers mound. Bags are sealed to keep blocks moist and ready to use. Avoid storing in direct sunlight and avoid freezing.



IMPROVEMENT WITH JUST 8 BLOCKS!

A package of 8 MoundMaster Blocks, placed on their side, can make a difference in the area in front of the rubber.

Surface Mound Clay Installation

Easy steps to safe and durable pitching mounds and batter's boxes.

Tools required: tamp, rake, shovel, broom, watering can and a slope board for the mound.

Installation Sequence:



STEP 1: Excavate the front slope of your mound to a 4" to 6" depth. Batter's boxes and catcher's box to a 4" depth.



STEP 2: Moisten the bottom of the hole with water. Add an inch of Surface Professional Mound Clay, and with a rake, cut into the soil for proper bonding. Tamp firmly. Lightly moisten, but do not drown and tamp again.



STEP 3: Evenly add an inch of new PMC at a time to the area you are working. Tamp until firm. Water the area lightly, but do not drown. Repeat STEP 3. As you reach the surface level, reduce the amount of water you add to the PMC.



STEP 4: Once you reach the surface of the mound, use a rake to rough grade the slope in front of the mound. Tamp or roll the slope for a smooth surface. Add PMC to any low spots and use your rake to cut down the high spots. After leveling, tamp or roll again.



STEP 5: Add a final coating of water on the PMC areas once all grades and slopes are set and rolled. Finally, topdress all PMC areas with 1/4" of infield mix and top with Surface MVP or Pro League to match the color of your infield.

Batter's Box Installation (Blocks and Clay)



Excavate the batter's box 3" deep.



Install MoundMaster Blocks, moisten, tamp, then fully water and allow to soak in for 20 minutes.



Apply a thin layer of Professional Mound Clay (match color to blocks) moisten, tamp.



Cover with a 1/4" layer of infield mix to finish grade. Top entire home plate or mound area with Surface MVP or Pro League.

APPROXIMATE NUMBER OF 50-LB BAGS FOR MOUND AND PLATE AREA

	4" depth	6" depth
Table	11 bags	17 bags
Landing Area	20 bags	30 bags
Batter's Boxes	38 bags	58 bags
Catcher's Box	13 bags	20 bags
TOTAL	82 bags	125 bags

Number of bags may vary depending on the size of the mound and batter's box. One pallet contains 40 bags. One bag weighs 50 pounds. One bag covers 5 square feet x 1" thick (compacted).

TIP #9

TURFACE® MOUNDMASTER® BLOCKS AVAILABLE IN RED OR GUMBO GRAY



ANTHONY DEFEO
Head Groundskeeper
Tennessee Smokies

Turface® MoundMaster® Blocks make it easier to maintain pitching and batting surfaces that provide your athletes with safe and consistent playing surfaces pitch after pitch. MoundMaster Blocks are made of high-quality packing clay formed into easy-to-use blocks for excellent durability. A single layer of Blocks will provide the foundation your players need when they take the field. And they'll appreciate it, because when you build and maintain the pitcher's mound and batter's boxes with the best, they can compete at their best.

MoundMaster Installation

When installing MoundMaster blocks, it's important place the blocks 10" before the shortest stride and 10" farther than the longest landing foot of your pitchers. Remember, too, they may pitch from either edge of the rubber, so the entire table around the mound should be built with MoundMaster Blocks.

Installation Sequence:



Outline your landing areas and plateau using a mound gauge to obtain the desired slope. Excavate 3" below the surface. Level and tamp firm.



Excavate the landing area and be 10" wider and longer than the longest stride of your pitchers. Blocks should be within a 1/2" of the surface.



Wedge the blocks into position.



Fill around blocks with adjacent soil and tamp to wedge together.



Tamp and water thoroughly several times for about an hour. Allow water to be absorbed into clay so blocks swell. Tamp firmly between watering.



Apply a thin layer of Professional Mound Clay (match color to blocks), moisten and tamp.



Add a light coating of infield mix and top with Turface MVP or Pro League. Consider using Pro League Heritage Red™ to provide color contrast on your mound and plate areas.



To repair holes, cut up blocks or use Professional Mound Clay®. Before repairing, sweep out hole to expose pure packing clay. Moisten exposed packing clay, add repair clay and pack using the bottom of a rake handle. Add more clay and repeat as necessary to reach a level surface.

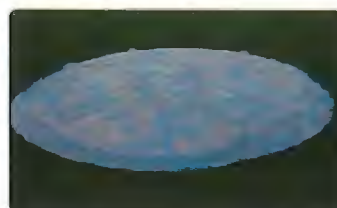

Cover your mound with a plastic tarp to hold moisture.

Pitcher's Mound

	FULL SIZE	REDUCED SIZE
Plateau	53 blocks	46 blocks
Landing Area	111 blocks	91 blocks

TOTAL 164 blocks 137 blocks

Batter's Box

	FULL SIZE	REDUCED SIZE
Batter's Box (total)	216 blocks	126 blocks
Catcher's Box	75 blocks	36 blocks

TOTAL 291 blocks 162 blocks

304 blocks per pallet (blocks are 2 1/2" x 4" x 8").

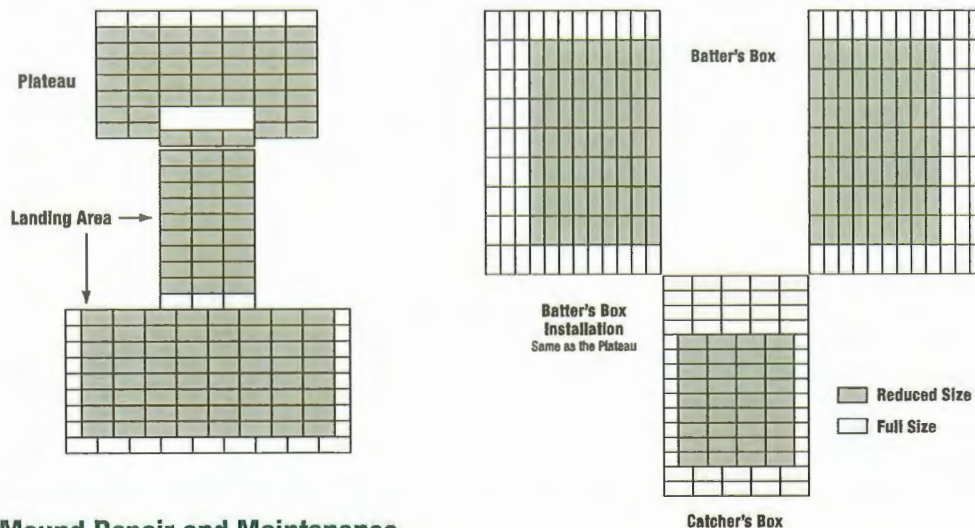

Mound Repair and Maintenance

- Moisture is the glue that holds clay together. Cover your mound when not in use and use a watering can to moisten the old clay to get it to bind to the new clay.
- Cut nuggets out of the MoundMaster® Blocks and store in a bucket with a lid and wet towels over them to use for daily repair and maintenance or use Turface® Professional Mound Clay® for repairs.
- Add a light coating of your infield mix and top with Turface® MVP® or Pro League® over the top of the MoundMaster Blocks.
- Watch your pitcher's stride and landing foot to determine how far out to bring the blocks.

Pitching Rubber Alignment

On a 90° field (high school, college or pro), the front of the pitching rubber must be 60' 6" from the apex (point) of home plate and the top of the rubber should be 10" above home plate. Follow these simple steps to set up your pitching rubber:

1. The pitching rubber is 24" long. Take a pencil and mark a line down the center.
2. Take a string from the apex of home plate and extend it to the second base peg.
3. Measure 60' 6" from the tip of home plate and sink a spike. This marks the front of the rubber.
4. Take a transit level and obtain a reading off home plate. The top of the pitching rubber must be 10" above home plate. Build or reduce height of the mound accordingly. If a transit level is not available, drive a stake at the apex of home plate measuring 10" high. Run a tight string over the pitching rubber and hang string level. Adjust the rubber height until line is level.
5. Square the rubber into position by taking a measuring tape and measure from the front left corner of home plate to the front left corner of the pitching rubber. Do the same on the right side. When these two measurements are equal, the rubber will be squared. Make sure that the rubber measures 12" on each side of the anchored spike.

Hint: If building a mound from scratch, it is a good idea to place a solid concrete block under the rubber to keep it from shifting.

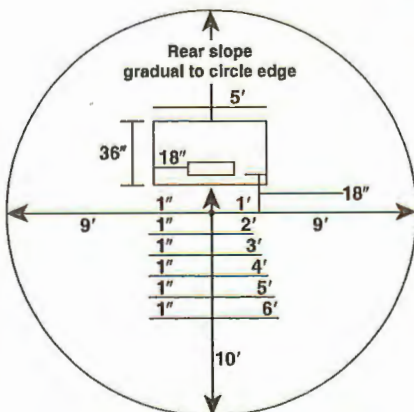

	HEIGHT	DISTANCE
90° field	10"	60' 6"
60° field	6"	40'-46'

Height of pitching mound above home plate

Distance measured from apex of home plate to front of pitching rubber

TIP #10

TURFACE ATHLETICS™ FOR OUTSTANDING TURF



KEN MROCK
Head Groundskeeper
Chicago Bears

Manipulating and designing soils to resist compaction and increase drainage are the key to having athletic fields hold up to intense use. Turface® and Profile® provide a unique opportunity to improve native or sand soils by adding pore space, moisture retention, nutrient holding capacity and increasing drainage.

"My Profile/sand soil mix is performing way beyond my expectations. The root mass is incredible!"

Core Aerify

Aerification is the most important turf maintenance practice. It helps to loosen compacted soils so air and water can move freely in your root zone. Core aerify in two directions. (REMEMBER: Avoid aerating in high heat or on the day of an event.)

Overseed

Every time you aerate and topdress you should take the time to overseed these areas to strengthen your turf. Select a grass variety with your local Turface distributor.

Topdress with Field & Fairway™

Field & Fairway is the perfect topdressing material for compacted areas. Its tremendous porosity and angular shape help resist the compaction of soils providing a loose and friable root zone even under intense athletic traffic. Field & Fairway holds moisture and nutrients at root level promoting strong root growth. The result is healthy turf coverage all season long. Topdress the aerified areas with 500 pounds of Field & Fairway per 1,000 square feet. This should be done twice a year: once in the spring and once in the fall.

FIELD & FAIRWAY



Natural

Emerald

Absorb Water and Mud with Field & Fairway

Make fields safe and playable while disguising worn or muddy areas with Field & Fairway Emerald. Just pour it into the muddy or wet area, rake and let absorb.

Patterns in Turf

If you are in the market for a mower, consider a reel-type mower. These mowers give your turf a much cleaner cut for stronger, more disease-resistant turf, and a better choice for making patterns in the turf.



KEN MROCK'S 6 STEPS TO A WINNING TURF FIELD

(CORE AERIFICATION PROGRAM FOR THE SPRING AND FALL)

- Turface® is not just an outstanding infield soil conditioner. It has been used extensively to modify turf soils, adding permanent water-, nutrient- and air-holding pore space.
- Many Major League Baseball, NFL, college and high school fields use Field & Fairway to absorb water and amend soils.
- Field & Fairway is successfully used in high compaction areas of golf courses, and high traffic landscape areas of hotels and office complexes.
- Use Field & Fairway during construction, after aerification, or to improve your topdressing blend.



STEP 1: Core aerify with multiple passes when conditions are proper to achieve maximum depth. Allow plugs to dry. Avoid aerification in high heat (80°+ F).



STEP 2: Apply Field & Fairway at a rate of 500 lb per 1,000 sq ft. You can use a topdresser, drop or push spreader fully open to evenly apply product.



STEP 3: After topdressing, seeding is important to establish a denser stand of turf. Contact a local Turface/Profile distributor for the recommended seed blend needed for your area.



STEP 4: Slowly drag the entire turf area with a mat drag to force materials into the turf and aerification holes. Best results occur if plugs are allowed to dry.



STEP 5: Fertilize. Contact a local Turface/Profile distributor to test your soil to determine proper types and amounts of fertilizer needed.



STEP 6: Water the entire field, but do not soak. Puddling may cause seeds to float, resulting in uneven growth.

Just Pour, Rake and Play

If the rains have already come—it's not too late. Turface instantly absorbs water for a safer playing surface. Apply Turface at a rate of 500 lbs per 1,000 sq ft to dry up muddy areas and create a safer, stable playing surface. In areas with standing water, dump and rake as necessary to eliminate water and mud.



FIELD ORIENTATION

Align the field so that the pitcher is throwing across the sunrise/sunset line.

Step 1: Triangulate the Backstop

If there is no backstop, position the apex of home plate in an appropriate spot. For positioning the apex of home plate using an existing backstop, start from one outside corner of the backstop and run a string or tape measure out to a couple of feet past where you think the pitching rubber will be. Scribe an arc. Repeat this process starting from the second post, making sure the second string or tape is the same length as the first.

Next, measure and locate the center of the backstop. Extend a straight line from this point out to where the arcs intersect. Position the apex of home plate on this line, and depending on which type of field, a prescribed distance from the backstop.

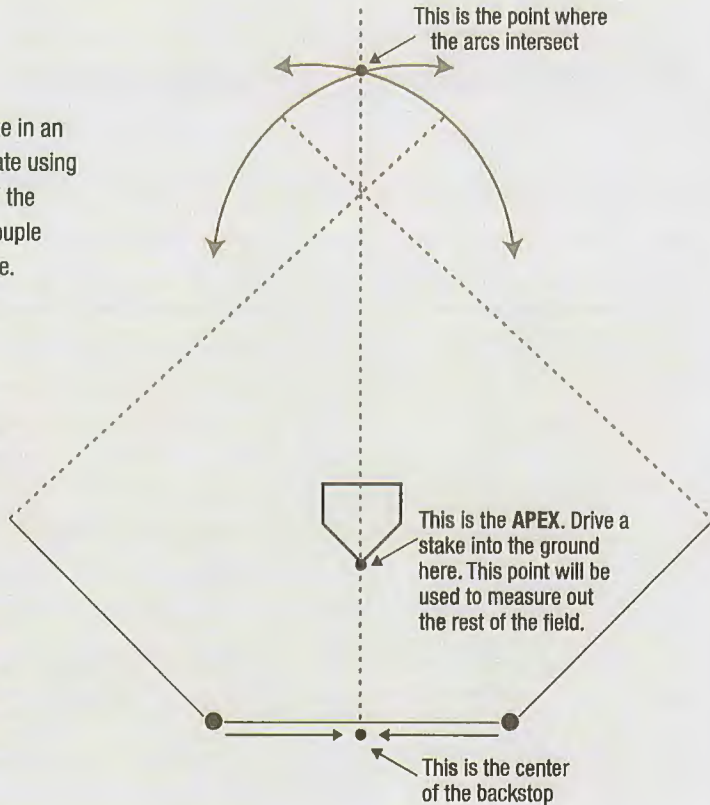

Recommended Distance from Backstop to Apex

	LEAGUE	DISTANCE
90' field	Baseball	60'
80' field	Pony	40'
70' field	Bronco	30'
60' field	Softball	25'
	Little League	25'
	Mustang	20'
50' field	Shetland/Pinto	20'

Distance measured from apex of home plate to center of backstop

Step 2: Locate Second Base

Run a line from the center point on the backstop, through the apex and over pitcher's mound to place second base on center. The distance to measure is from the apex of home plate to the center of second base.

Distance from Apex to Center of Second Base

	LEAGUE	DISTANCE
90' field	Baseball	127' 3 3/8"
80' field	Pony	113' 1 5/8"
70' field	Bronco	99'
60' field	Softball	84' 10 1/4"
	Little League	84' 10 1/4"
	Mustang	84' 10 1/4"
50' field	Shetland/Pinto	70' 8 1/2"

These measurements are identical to the distance from the outside back corner of third base to the outside back corner of first base.

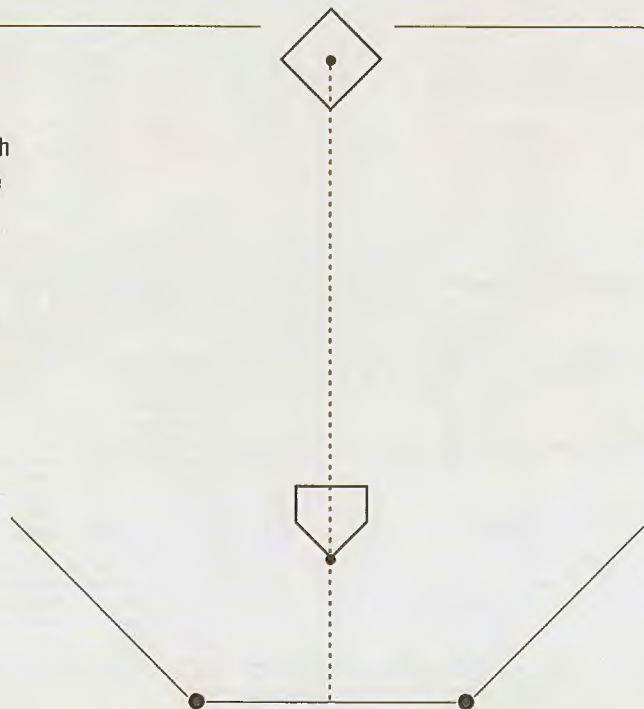

Step 3: Locate First Base and Third Base

Measure the appropriate baseline distance to third base from the apex and scribe an arc. Measure the same distance from the center of second base to third base and scribe another arc. Place the outside back corner of the base where the arcs intersect. Repeat to locate first base.

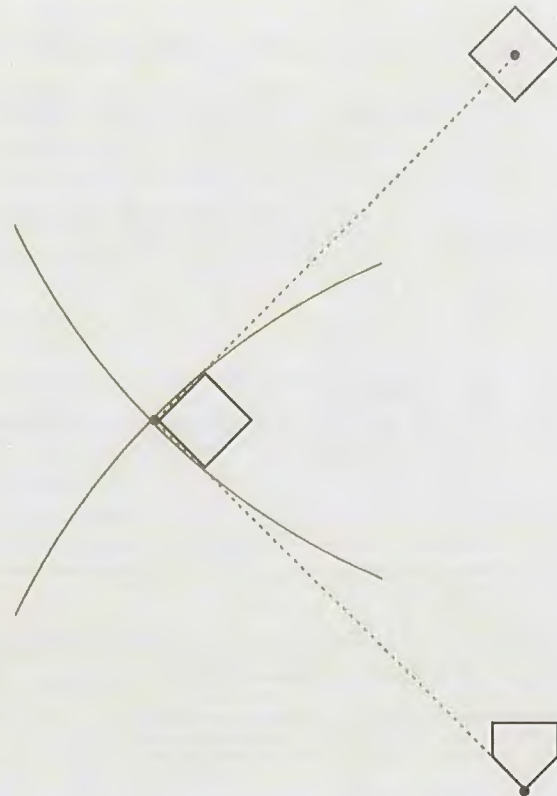

Distance from Apex and Second Base to First or Third Base

	LEAGUE	DISTANCE
90' field	Baseball	90'
80' field	Pony	80'
70' field	Bronco	70'
60' field	Softball	60'
	Little League	60'
	Mustang	60'
50' field	Shetland/Pinto	50'

Step 4: Set Home Plate

Draw a line from the outside back corner of third base to the apex and from the outside back corner of first base to the apex. Align the back angles of home plate to match up with these lines.

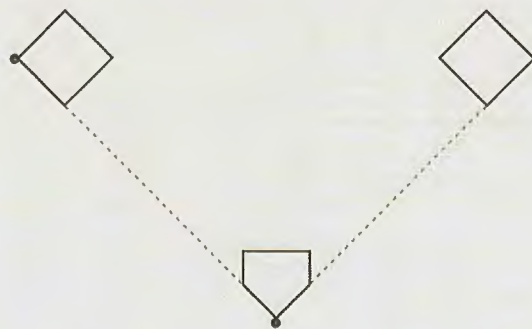

Step 5: Set Pitching Rubber

Following the straight line from the apex to the center of second base, measure a line from the apex to the spot where the front of the pitching rubber will be. Square up the pitching rubber by measuring an equal distance from the front corners of home plate to the corresponding corners on the pitching rubber.



Distance from Apex to Front of Pitching Rubber

	BASEBALL LEAGUE	DISTANCE
90' field	Baseball	60' 6"
80' field	Pony	54'
70' field	Bronco	48'
60' field	Little League	46'
	Mustang	44'
50' field	Shetland/Pinto	38'

	SOFTBALL LEAGUE	DISTANCE
	Softball	46'
60' field	Pony/Colt/Palomino Fast-Pitch	46'
	Bronco Slow-Pitch	40'
50' field	Shetland/Pinto/Mustang	35'

SHETLAND/PINTO

50' FIELD

Bases:

- Pinto Baseball – 50'
- Shetland Softball – 55'
- Pinto Softball – 55'
- Mustang Softball – 55'

Pitching:

- Pinto Baseball – 38'
- Shetland Softball – 35'
- Pinto Softball – 35'
- Mustang Softball – 35'

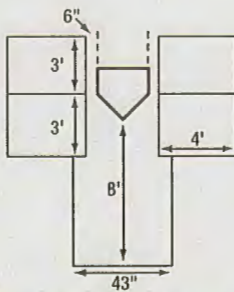

Catcher's and Batter's Boxes

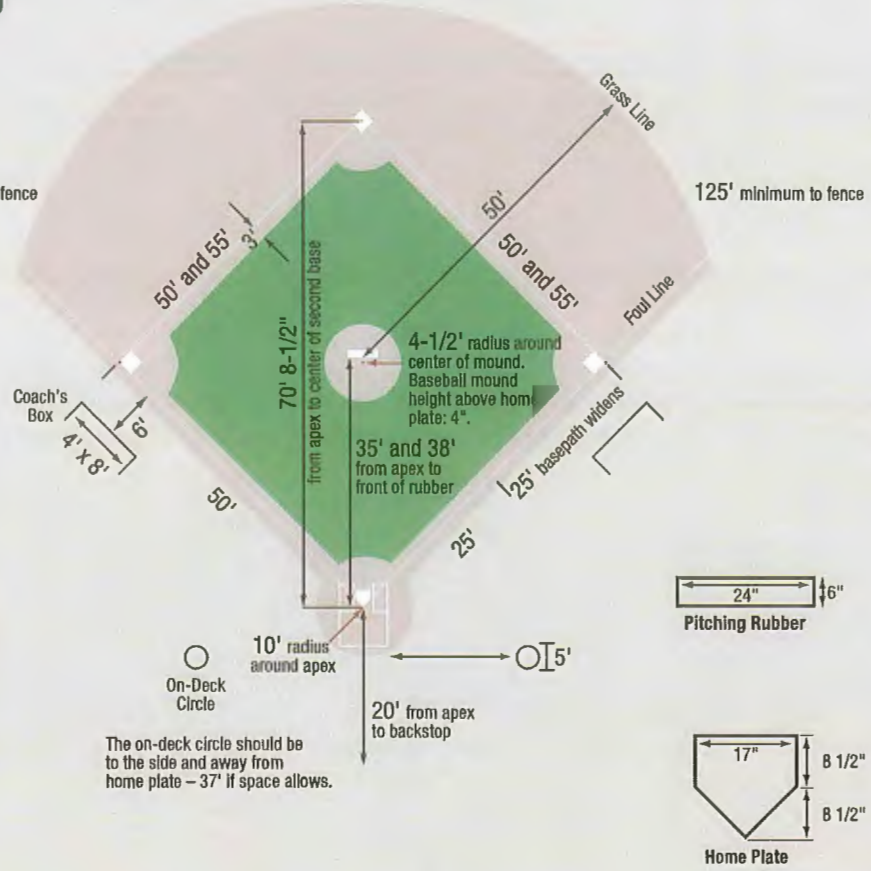

LITTLE LEAGUE

60' FIELD

Bases:

- Pinto Baseball – 50'
- Shetland Softball – 55'
- Pinto Softball – 55'
- Mustang Softball – 55'

Pitching:

- Pinto Baseball – 38'
- Shetland Softball – 35'
- Pinto Softball – 35'
- Mustang Softball – 35'

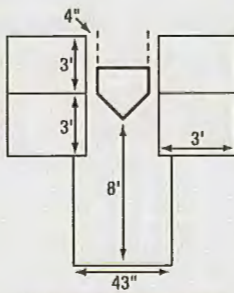

Catcher's and Batter's Boxes

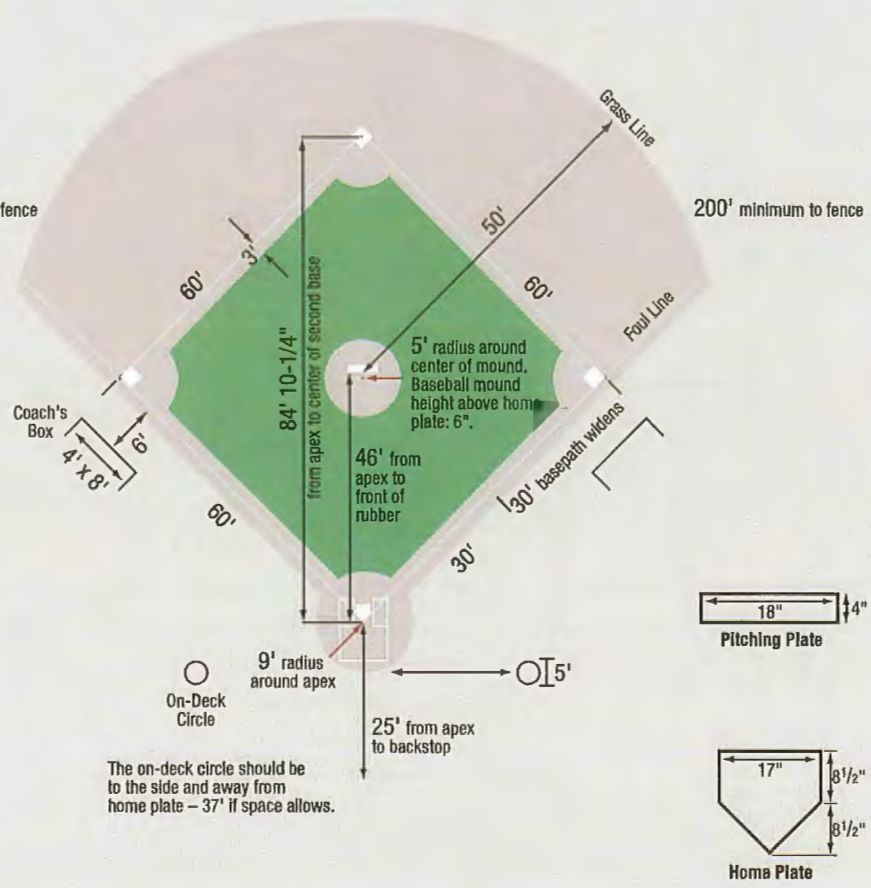

MUSTANG

60' FIELD

Bases:

- Mustang Baseball – 60'
- Bronco Softball – 60'
- Pony Softball – 60'
- Colt Softball – 60'
- Palomino Softball – 60'

Pitching:

- Mustang Baseball – 44'
- Bronco Softball – 40' (Slow Pitch)
- Pony Softball – 46' (Fast Pitch)
- Colt Softball – 46' (Fast Pitch)
- Palomino Softball – 46' (Fast Pitch)

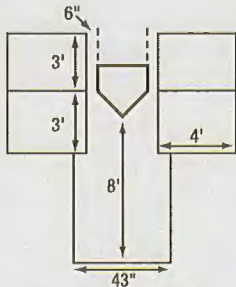

Catcher's and Batter's Boxes

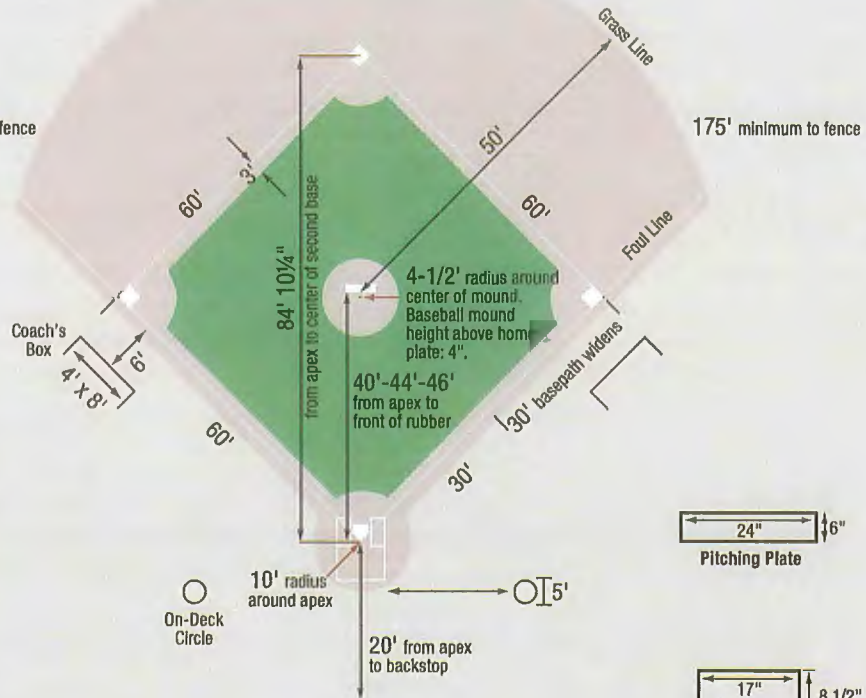

Pitching Plate

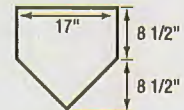

Home Plate

BRONCO

70' FIELD

Bases:

- Bronco Baseball – 70'
- Bronco Softball – 70'
- Pony Softball – 70'
- Colt Softball – 70'
- Palomino Softball – 70'

Pitching:

- Bronco Baseball – 44'
- Bronco Softball – 40' (Slow Pitch)
- Pony Softball – 46' (Fast Pitch)
- Colt Softball – 46' (Fast Pitch)
- Palomino Softball – 46' (Fast Pitch)

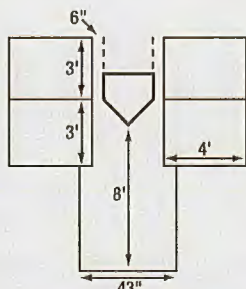

Catcher's and Batter's Boxes

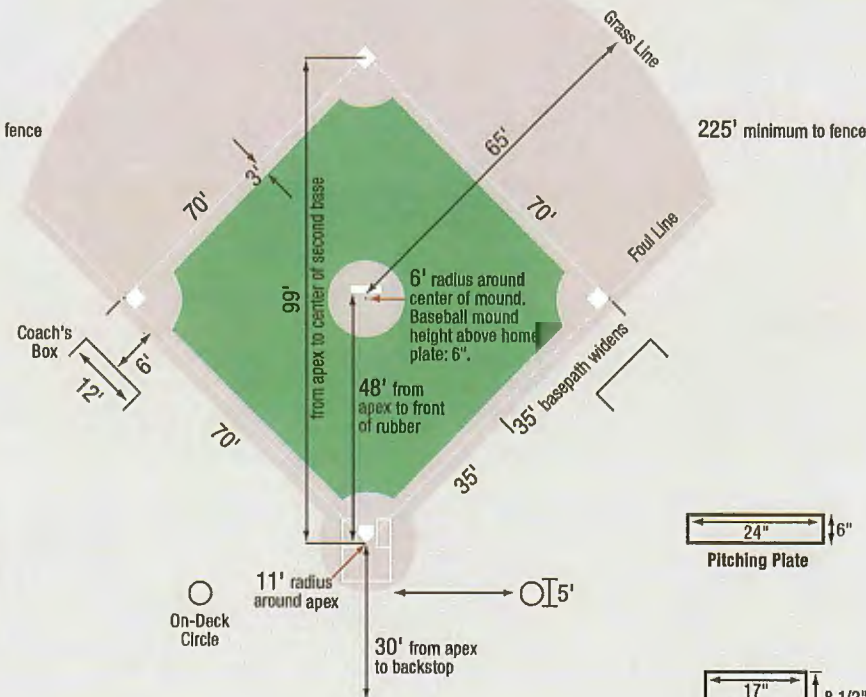

Pitching Plate

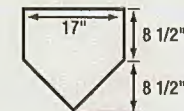

Home Plate

PONY

80' FIELD

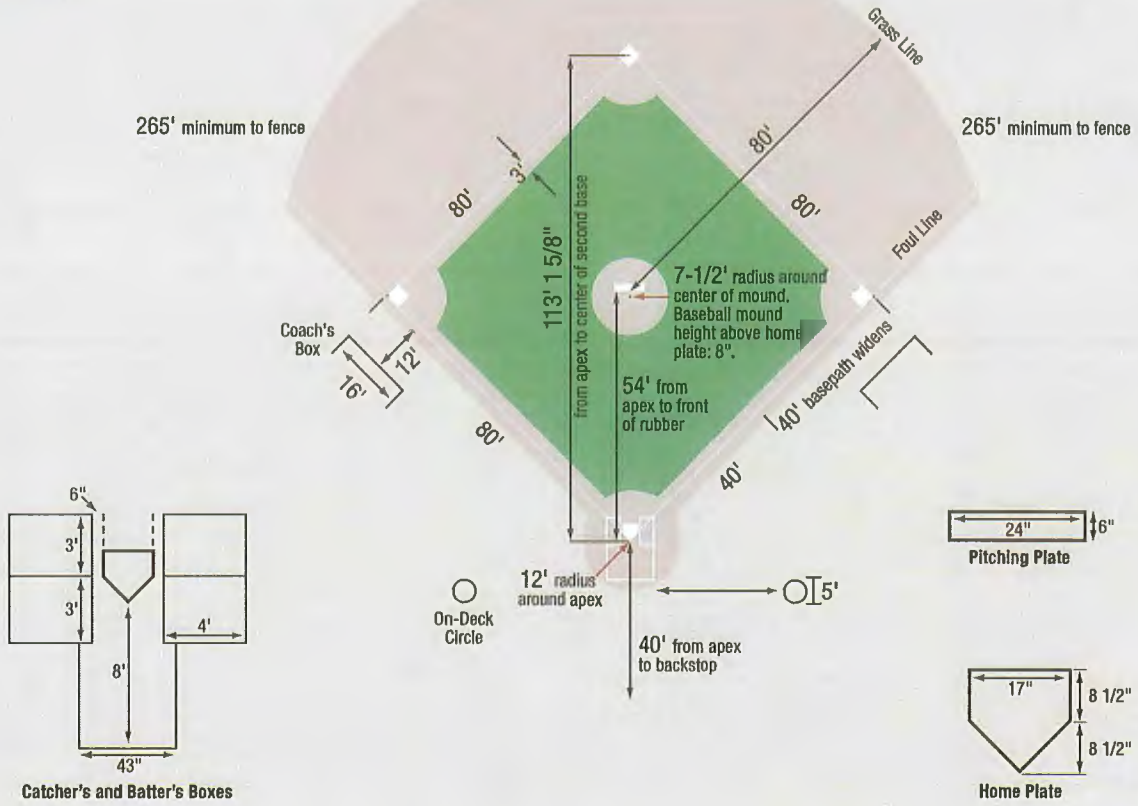

BASEBALL

90' FIELD

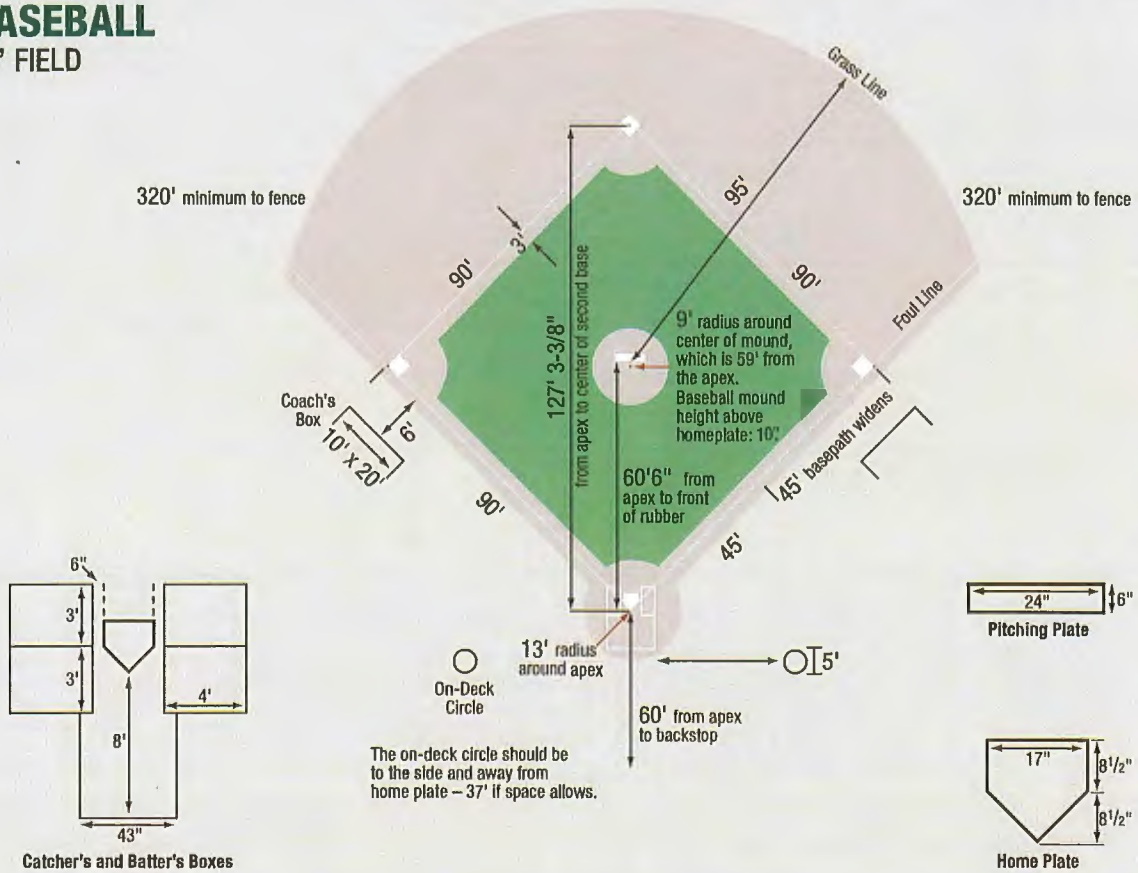

SOFTBALL

60' FIELD

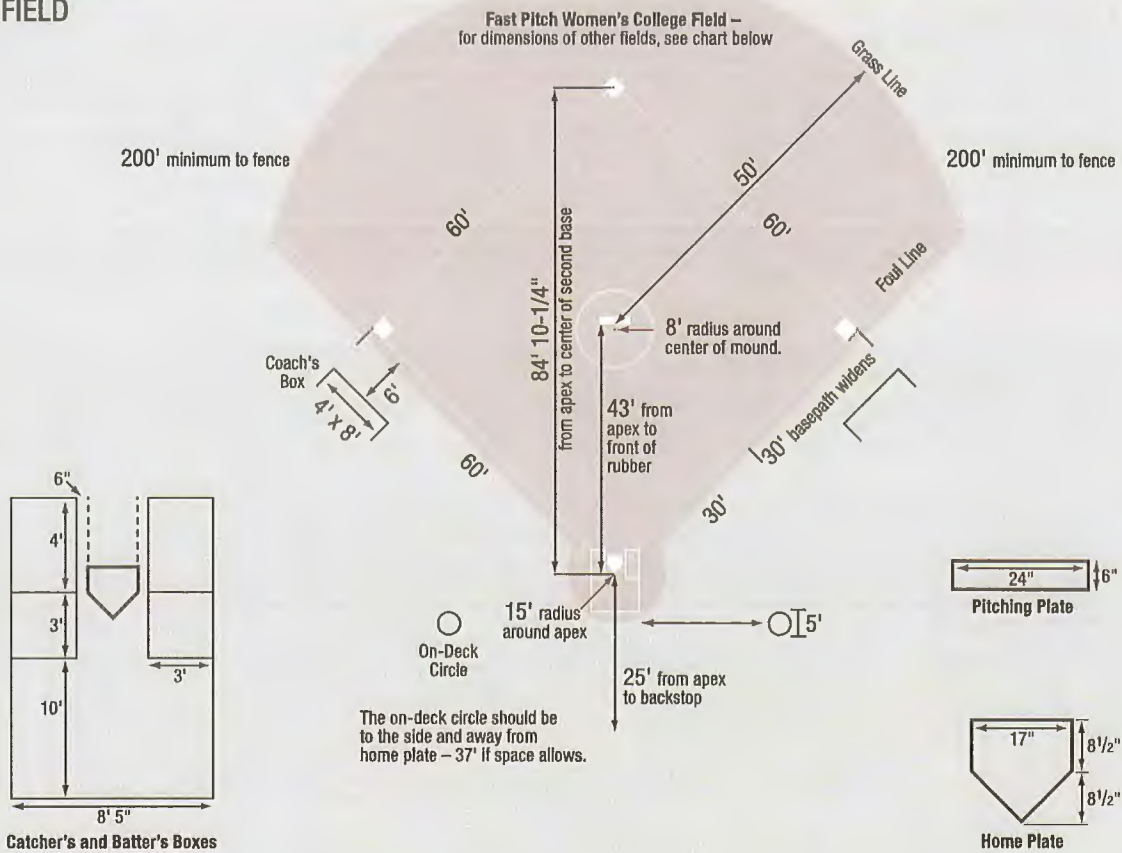

Distance Table

Adult	Division	Bases	Pitching	Min. Fence	Max. Fence
Fast Pitch	Women (High School)	60' (18.29m)	43' (12.19m)	200' (60.96m)	250' (76.20m)
	Women (College)	60' (18.29m)	43' (13.11m)	200' (60.96m)	250' (76.20m)
	Men	60' (18.29m)	46' (14.02m)	225' (68.58m)	250' (76.20m)
Modified Pitch	Women	60' (18.29m)	40' (12.19m)	200' (60.96m)	
	Men	60' (18.29m)	46' (14.02m)	265' (80.80m)	
Slow Pitch	Women	65' (19.81m)	50' (15.24m)	265' (80.80m)	275' (83.82m)
	Men	65' (19.81m)	50' (15.24m)	275' (83.82m)	315' (96.01m)
	Coed	65' (19.81m)	50' (15.24m)	275' (83.82m)	300' (91.44m)
	Super	65' (19.81m)	50' (15.24m)	325' (99.06m)	
16-Inch Slow Pitch	Women	55' (16.76m)	38' (11.58m)	200' (60.96m)	
	Men	55' (16.76m)	38' (11.58m)	250' (76.20m)	
14-Inch Slow Pitch	Women and Men	60' (18.29m)	46' (14.02m)		
Youth	Division	Bases	Pitching	Min. Fence	Max. Fence
Slow Pitch	Girls & Boys 10-under	55' (16.76m)	35' (10.76m)	150' (45.72m)	175' (53.34m)
	Girls & Boys 12-under	60' (16.76m)	40' (12.19m)	175' (53.34m)	200' (60.96m)
	Girls 14-under	65' (19.81m)	46' (14.02m)	225' (68.58m)	250' (76.20m)
	Boys 14-under	65' (19.81m)	46' (14.02m)	250' (76.20m)	275' (83.82m)
	Girls 16-under	65' (19.81m)	50' (15.24m)	225' (68.58m)	250' (76.20m)
	Boys 16-under	65' (19.81m)	50' (15.24m)	275' (83.82m)	300' (91.44m)
	Girls 18-under	65' (19.81m)	50' (15.24m)	225' (68.58m)	250' (76.20m)
	Boys 18-under	65' (19.81m)	50' (15.24m)	275' (83.82m)	300' (91.44m)
Fast Pitch	Girls & Boys 10-under	55' (16.76m)	35' (10.76m)	150' (45.72m)	175' (53.34m)
	Girls 12-under	60' (18.29m)	35' (10.76m)	175' (53.34m)	200' (60.96m)
	Boys 12-under	60' (18.29m)	40' (12.19m)	175' (53.34m)	200' (60.96m)
	Girls 14-under	60' (18.29m)	40' (12.19m)	175' (53.34m)	200' (60.96m)
	Boys 14-under	60' (18.29m)	46' (14.02m)	175' (53.34m)	200' (60.96m)
	Girls 16-under	60' (18.29m)	40' (12.19m)	200' (60.96m)	225' (68.58m)
	Boys 16-under	60' (18.29m)	46' (14.02m)	200' (60.96m)	225' (68.58m)
	Girls 18-under Boys 18-under	60' (18.29m) 60' (18.29m)	40' (12.19m) 46' (14.02m)	200' (60.96m) 200' (60.96m)	225' (68.58m) 225' (68.58m)

TURFACE ATHLETICS™ / More Video Tips

The Turface® video library has been expanded. Now even more instructional information and "how-to" tips are available to help you improve and maintain sports fields. A few of the recently added topics to help you provide safe and playable surfaces include Testing an Infield Mix, Turf Management and The Science of Infields. New videos are being produced all the time, so check back often to view the latest additions at www.turface.com/videos.



With the valued partnerships we have established with these outstanding organizations, we are even better able to further our commitment to

KEEP AMERICA PLAYING.



©2019. All Minor League Baseball trademarks and copyrights are used with permission. All rights reserved. Visit www.MiLB.com.



THE #1 CONDITIONER FOR SAFE & PLAYABLE FIELDS.

Turfacer® products enable fields to perform to their fullest, through wet springs and dry summers—on more fields across America than any other brand. For over 50 years no one has done it better.

Turfacer is a sports field conditioner, not crushed aggregate like brick dust and vitrified clay, which are commonly used as infield colorants. If you already have these materials on your field, Turfacer should be incorporated into the mix to prevent compaction and to improve moisture absorption.

Become part of Turfacer Athletics™ and you'll get a broad range of infield and soil conditioners to prevent rainouts and maximize safety on any athletic field. You'll also be connected to the industry's largest network of sports field knowledge.



Turfacer is the #1 choice at every level of baseball and softball, providing major league color and performance.

- ✓ Preferred by Major and Minor League groundskeepers.
- ✓ Relied on by thousands of high school and college coaches.
- ✓ Used by thousands of park and recreational facilities.
- ✓ Chosen for Olympic baseball and softball fields.

ON SKINNED INFIELDS: Turfacer® MVP® improves drainage and reduces compaction, while Turfacer® Quick Dry® eliminates puddles and standing water. For the ultimate fielding and sliding surface use Turfacer® Pro League®, Pro League® Red, Heritage Red or Champion Brown™, which combines rich brown color with proven infield conditioning.

ON TURF: Field & Fairway™ Emerald can be used to conceal worn areas of your turf, absorb water to make muddy areas playable, and improve soil all the way down through the root zone.

Pro League Heritage Red
An appealing and rich cherrywood color, whether it is wet or dry.

Pro League Red
This classic color is a popular choice to enhance infield appearance.

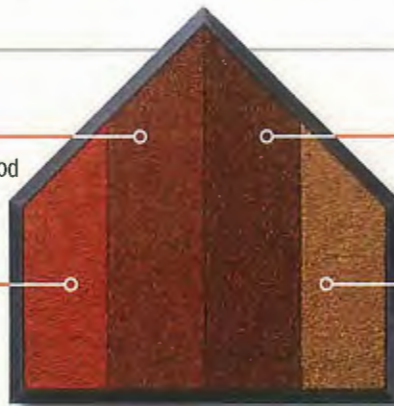

Pro League Champion Brown
A unique, deep, dark color for a first-class look and provides excellent ball visibility.

Pro League Natural
Non-dyed conditioner delivers exceptional performance and a classic look.

BETTER COLORS. BETTER PERFORMANCE.

With a choice of colors to enhance aesthetics and improve ball visibility, Pro League gives you every advantage to bring home a safer, more playable field.



"I've relied on the safety and playability of Turfacer on my field for years, and with a great color to enhance visibility and aesthetics, overall performance and appearance are second to none."

Larry DiVito
Head Groundskeeper
Minnesota Twins

visit TURFACE.COM for more educational content and how-to videos

